



Cisco VG350 Voice Gateway Hardware Installation Guide

THE SPECIFICATIONS AND INFORMATION REGARDING THE PRODUCTS IN THIS MANUAL ARE SUBJECT TO CHANGE WITHOUT NOTICE. ALL STATEMENTS, INFORMATION, AND RECOMMENDATIONS IN THIS MANUAL ARE BELIEVED TO BE ACCURATE BUT ARE PRESENTED WITHOUT WARRANTY OF ANY KIND, EXPRESS OR IMPLIED. USERS MUST TAKE FULL RESPONSIBILITY FOR THEIR APPLICATION OF ANY PRODUCTS.

Americas Headquarters
Cisco Systems, Inc.
170 West Tasman Drive
San Jose, CA 95134-1706
USA
<http://www.cisco.com>
Tel: 408 526-4000
800 553-NETS (6387)
Fax: 408 527-0883

Last Revised: December 5, 2012
Text Part Number: OL-25970-01

THE SOFTWARE LICENSE AND LIMITED WARRANTY FOR THE ACCOMPANYING PRODUCT ARE SET FORTH IN THE INFORMATION PACKET THAT SHIPPED WITH THE PRODUCT AND ARE INCORPORATED HEREIN BY THIS REFERENCE. IF YOU ARE UNABLE TO LOCATE THE SOFTWARE LICENSE OR LIMITED WARRANTY, CONTACT YOUR CISCO REPRESENTATIVE FOR A COPY.

The following information is for FCC compliance of Class A devices: This equipment has been tested and found to comply with the limits for a Class A digital device, pursuant to part 15 of the FCC rules. These limits are designed to provide reasonable protection against harmful interference when the equipment is operated in a commercial environment. This equipment generates, uses, and can radiate radio-frequency energy and, if not installed and used in accordance with the instruction manual, may cause harmful interference to radio communications. Operation of this equipment in a residential area is likely to cause harmful interference, in which case users will be required to correct the interference at their own expense.

The following information is for FCC compliance of Class B devices: This equipment has been tested and found to comply with the limits for a Class B digital device, pursuant to part 15 of the FCC rules. These limits are designed to provide reasonable protection against harmful interference in a residential installation. This equipment generates, uses and can radiate radio frequency energy and, if not installed and used in accordance with the instructions, may cause harmful interference to radio communications. However, there is no guarantee that interference will not occur in a particular installation. If the equipment causes interference to radio or television reception, which can be determined by turning the equipment off and on, users are encouraged to try to correct the interference by using one or more of the following measures:

- Reorient or relocate the receiving antenna.
- Increase the separation between the equipment and receiver.
- Connect the equipment into an outlet on a circuit different from that to which the receiver is connected.
- Consult the dealer or an experienced radio/TV technician for help.

Modifications to this product not authorized by Cisco could void the FCC approval and negate your authority to operate the product.

The Cisco implementation of TCP header compression is an adaptation of a program developed by the University of California, Berkeley (UCB) as part of UCB's public domain version of the UNIX operating system. All rights reserved. Copyright © 1981, Regents of the University of California.

NOTWITHSTANDING ANY OTHER WARRANTY HEREIN, ALL DOCUMENT FILES AND SOFTWARE OF THESE SUPPLIERS ARE PROVIDED "AS IS" WITH ALL FAULTS. CISCO AND THE ABOVE-NAMED SUPPLIERS DISCLAIM ALL WARRANTIES, EXPRESSED OR IMPLIED, INCLUDING, WITHOUT LIMITATION, THOSE OF MERCHANTABILITY, FITNESS FOR A PARTICULAR PURPOSE AND NONINFRINGEMENT OR ARISING FROM A COURSE OF DEALING, USAGE, OR TRADE PRACTICE.

IN NO EVENT SHALL CISCO OR ITS SUPPLIERS BE LIABLE FOR ANY INDIRECT, SPECIAL, CONSEQUENTIAL, OR INCIDENTAL DAMAGES, INCLUDING, WITHOUT LIMITATION, LOST PROFITS OR LOSS OR DAMAGE TO DATA ARISING OUT OF THE USE OR INABILITY TO USE THIS MANUAL, EVEN IF CISCO OR ITS SUPPLIERS HAVE BEEN ADVISED OF THE POSSIBILITY OF SUCH DAMAGES.

Cisco and the Cisco logo are trademarks or registered trademarks of Cisco and/or its affiliates in the U.S. and other countries. To view a list of Cisco trademarks, go to this URL: www.cisco.com/go/trademarks. Third-party trademarks mentioned are the property of their respective owners. The use of the word partner does not imply a partnership relationship between Cisco and any other company. (1110R)

Any Internet Protocol (IP) addresses and phone numbers used in this document are not intended to be actual addresses and phone numbers. Any examples, command display output, network topology diagrams, and other figures included in the document are shown for illustrative purposes only. Any use of actual IP addresses or phone numbers in illustrative content is unintentional and coincidental.

Cisco VG350 Voice Gateway Hardware Installation Guide

© 2012 Cisco Systems, Inc. All rights reserved.



CONTENTS

Preface vii

| | |
|---|--------|
| Audience | -vii |
| Organization | -vii |
| Conventions | -viii |
| Safety Warnings | -ix |
| Warning Definition | -ix |
| Related Documentation | -xv |
| Cisco.com | -xv |
| Ordering Documentation | -xvi |
| Documentation Feedback | -xvi |
| Cisco Technical Support Website | -xvi |
| Submitting a Service Request | -xvii |
| Definitions of Service Request Severity | -xvii |
| Obtaining Additional Publications and Information | -xviii |

CHAPTER 1

Overview of the Cisco VG350 Voice Gateway 1-1

| | |
|-------------------------------------|-----|
| Overview | 1-1 |
| 1-1 | |
| VG350 Voice Gateway Chassis | 1-2 |
| Configuration Options | 1-3 |
| Interfaces and Service Capabilities | 1-3 |
| Physical Description and LEDs | 1-4 |
| LED Indicators | 1-4 |
| Specifications | 1-6 |
| Software Elements | 1-9 |
| Configuration Connections | 1-9 |
| Configuration Methods | 1-9 |
| Automated Configuration | 1-9 |
| Manual Configuration | 1-9 |

CHAPTER 2

Cisco Double-Wide High Density Analog Service Modules 2-1

| | |
|---|-----|
| Double-Wide High Density Analog Service Module Overview | 2-2 |
|---|-----|

| | |
|---|-----|
| Installing SM-D-72FXS | 2-3 |
| Grounding | 2-3 |
| Cables | 2-3 |
| Connecting SM-D-72FXS | 2-3 |
| Installing SM-D-48FXS-E | 2-4 |
| Grounding | 2-4 |
| Cables | 2-4 |
| Connecting SM-D-48FXS-E | 2-4 |
| FXO Fail-Over Bypass Ports | 2-5 |
| Cisco SM-D-72FXS Service Module Specifications | 2-6 |
| Physical Description and LEDs | 2-6 |
| Cisco SM-D-48FXS-E Service Module Specifications | 2-6 |
| Physical Description and LEDs | 2-6 |
| Port Numbering Conventions | 2-7 |
| Connecting to the Double-Wide High Density Service Module Ports | 2-7 |
| Online Insertion and Removal | 2-7 |
| Insertion and Removal Steps | 2-8 |
| Insertion | 2-8 |
| Removal | 2-8 |
| EN LED | 2-8 |

CHAPTER 3**Planning Your Installation** 3-1

| | |
|--|-----|
| Location and Mounting Requirements | 3-1 |
| Temperature Control and Ventilation | 3-1 |
| Enclosed Racks | 3-2 |
| Bench-Mounted | 3-2 |
| Access to Chassis | 3-2 |
| Chassis Grounding | 3-2 |
| Power Source | 3-3 |
| Cable Types | 3-4 |
| Distance Limitations for Interface Cables | 3-4 |
| Gigabit Ethernet Maximum Distance | 3-4 |
| FXS Analog Voice Port Maximum Distance | 3-4 |
| FXS-E (Extended loop) Analog Voice Port Maximum Distance | 3-4 |
| Interference Considerations | 3-5 |

CHAPTER 4**Installing the Cisco VG350 Voice Gateway** 4-1

| | |
|------------------------|-----|
| Safety Recommendations | 4-2 |
|------------------------|-----|

| | |
|---|-----|
| Maintaining Safety with Electricity | 4-2 |
| General Safety Practices | 4-4 |
| Safety Tips | 4-4 |
| Preventing Electrostatic Discharge Damage | 4-5 |
| Site Log | 4-5 |
| Keeping Track—Checklist | 4-6 |
| Installation Checklist | 4-6 |
| Mounting Tools and Equipment | 4-7 |
| Unpacking and Inspection | 4-7 |

CHAPTER 5**Powering On the Cisco VG350 Voice Gateway** 5-1

| | |
|------------------------|-----|
| Checklist for Power-On | 5-1 |
| Power-On Procedure | 5-1 |
| Troubleshooting | 5-3 |

APPENDIX A**Cable Specifications and Information** A-1

| | |
|--|-----|
| Console and Auxiliary Port Cables and Pinouts | A-1 |
| Console Port to PC | A-2 |
| Console Port to ASCII Terminal | A-3 |
| Auxiliary Port to Modem | A-4 |
| Alternative Connections to Terminal and Modem | A-4 |
| Gigabit Ethernet Port Pinouts (RJ-45) | A-5 |
| Analog Voice Multipoint Pinouts (RJ-21X/CA21A) | A-6 |



Preface

This preface discusses the audience, organization, and conventions of this publication and describes how to obtain additional documentation.

Audience

This publication is designed for experienced IT technicians familiar with Cisco products, IOS CLI, and concepts and technologies of networking. This document can also be used by experienced telecommunications administrators familiar with Cisco Unified Communications Manager and/or Cisco Unified Communications Manager Business Edition and/or Cisco Unified Communications Manager Express.



Warning

Only trained and qualified personnel should be allowed to install, replace, or service this equipment.
Statement 1030

Organization

Table 1 Major Sections of This Guide

| Chapter | Title | Description |
|------------|---|---|
| Chapter 1 | Overview of the Cisco VG350 Voice Gateway | Features and specifications of the Cisco VG350 Voice Gateway. |
| Chapter 2 | Cisco Double-Wide High Density Analog Service Modules | Information including specifications of the the Double-Wide High Density Service Modules. |
| Chapter 3 | Planning Your Installation | Environmental requirements and cable routing considerations. |
| Chapter 4 | Installing the Cisco VG350 Voice Gateway | Instructions for installing the Cisco VG350 Voice Gateway and connecting the cables. |
| Chapter 5 | Powering On the Cisco VG350 Voice Gateway | Powering up the Cisco VG350 Voice Gateway and preparing for configuration. |
| Appendix A | Cable Specifications and Information | Pinouts for the Cisco VG350 Voice Gateway ports and cables. |

Conventions

Table 2 *Installation Guide Conventions*

| Convention | Description |
|-----------------------------|--|
| boldface font | Commands and keywords. |
| <i>italic font</i> | Variables for which you supply values. |
| [] | Keywords or arguments that appear within square brackets are optional. |
| {x y z} | A choice of required keywords appears in braces separated by vertical bars. You must select one. |
| screen font | Examples of information displayed on the screen. |
| boldface screen font | Examples of information you must enter. |
| < > | Nonprinting characters, for example, passwords, appear in angle brackets in contexts where italic font is not available. |
| [] | Default responses to system prompts appear in square brackets. |



Note

Means *reader take note*. Notes contain helpful suggestions or references to materials not contained in this publication.



Timesaver

Means *the described action saves time*. You can save time by performing the action described in the paragraph.



Caution

Means *reader be careful*. In this situation, you might do something that could result in equipment damage or loss of data.



Tip

Means *the following information will help you solve a problem*. The tips information might not be troubleshooting or even an action, but could be useful information, similar to a Timesaver.

Safety Warnings

Safety warnings appear throughout this publication in procedures that, if performed incorrectly, may harm you. A warning symbol precedes each warning statement. To see translations of the warnings that appear in this publication, refer to [Cisco VG350 Voice Gateway Regulatory Compliance and Safety Information](#).

Warning Definition



Warning

IMPORTANT SAFETY INSTRUCTIONS

This warning symbol means danger. You are in a situation that could cause bodily injury. Before you work on any equipment, be aware of the hazards involved with electrical circuitry and be familiar with standard practices for preventing accidents. Use the statement number provided at the end of each warning to locate its translation in the translated safety warnings that accompanied this device. Statement 1071

SAVE THESE INSTRUCTIONS

Waarschuwing

BELANGRIJKE VEILIGHEIDSINSTRUCTIES

Dit waarschuwingssymbool betekent gevaar. U verkeert in een situatie die lichamelijk letsel kan veroorzaken. Voordat u aan enige apparatuur gaat werken, dient u zich bewust te zijn van de bij elektrische schakelingen betrokken risico's en dient u op de hoogte te zijn van de standaard praktijken om ongelukken te voorkomen. Gebruik het nummer van de verklaring onderaan de waarschuwing als u een vertaling van de waarschuwing die bij het apparaat wordt geleverd, wilt raadplegen.

BEWAAR DEZE INSTRUCTIES

Varoitus

TÄRKEITÄ TURVALLISUUSOHJEITA

Tämä varoitusmerkki merkitsee vaaraa. Tilanne voi aiheuttaa ruumiillisia vammoja. Ennen kuin käsittelet laitteistoa, huomioi sähköpiirien käsittelemiseen liittyvät riskit ja tutustu onnettomuuksien yleisiin ehkäisytapoihin. Turvallisuusvaroitusten käännökset löytyvät laitteen mukana toimitettujen käännettyjen turvallisuusvaroitusten joukosta varoitusten lopussa näkyvien lausuntonumeroiden avulla.

SÄILYTÄ NÄMÄ OHJEET

Attention

IMPORTANTES INFORMATIONS DE SÉCURITÉ

Ce symbole d'avertissement indique un danger. Vous vous trouvez dans une situation pouvant entraîner des blessures ou des dommages corporels. Avant de travailler sur un équipement, soyez conscient des dangers liés aux circuits électriques et familiarisez-vous avec les procédures couramment utilisées pour éviter les accidents. Pour prendre connaissance des traductions des avertissements figurant dans les consignes de sécurité traduites qui accompagnent cet appareil, référez-vous au numéro de l'instruction situé à la fin de chaque avertissement.

CONSERVEZ CES INFORMATIONS

Warnung WICHTIGE SICHERHEITSHINWEISE

Dieses Warnsymbol bedeutet Gefahr. Sie befinden sich in einer Situation, die zu Verletzungen führen kann. Machen Sie sich vor der Arbeit mit Geräten mit den Gefahren elektrischer Schaltungen und den üblichen Verfahren zur Vorbeugung vor Unfällen vertraut. Suchen Sie mit der am Ende jeder Warnung angegebenen Anweisungsnummer nach der jeweiligen Übersetzung in den übersetzten Sicherheitshinweisen, die zusammen mit diesem Gerät ausgeliefert wurden.

BEWAHREN SIE DIESE HINWEISE GUT AUF.

Avvertenza IMPORTANTI ISTRUZIONI SULLA SICUREZZA

Questo simbolo di avvertenza indica un pericolo. La situazione potrebbe causare infortuni alle persone. Prima di intervenire su qualsiasi apparecchiatura, occorre essere al corrente dei pericoli relativi ai circuiti elettrici e conoscere le procedure standard per la prevenzione di incidenti. Utilizzare il numero di istruzione presente alla fine di ciascuna avvertenza per individuare le traduzioni delle avvertenze riportate in questo documento.

CONSERVARE QUESTE ISTRUZIONI

Advarsel VIKTIGE SIKKERHETSINSTRUKSJONER

Dette advarselssymbolet betyr fare. Du er i en situasjon som kan føre til skade på person. Før du begynner å arbeide med noe av utstyret, må du være oppmerksom på farene forbundet med elektriske kretser, og kjenne til standardprosedyrer for å forhindre ulykker. Bruk nummeret i slutten av hver advarsel for å finne oversettelsen i de oversatte sikkerhetsadvarslene som fulgte med denne enheten.

TA VARE PÅ DISSE INSTRUKSJONENE

Aviso INSTRUÇÕES IMPORTANTES DE SEGURANÇA

Este símbolo de aviso significa perigo. Você está em uma situação que poderá ser causadora de lesões corporais. Antes de iniciar a utilização de qualquer equipamento, tenha conhecimento dos perigos envolvidos no manuseio de circuitos elétricos e familiarize-se com as práticas habituais de prevenção de acidentes. Utilize o número da instrução fornecido ao final de cada aviso para localizar sua tradução nos avisos de segurança traduzidos que acompanham este dispositivo.

GUARDE ESTAS INSTRUÇÕES

¡Advertencia! INSTRUCCIONES IMPORTANTES DE SEGURIDAD

Este símbolo de aviso indica peligro. Existe riesgo para su integridad física. Antes de manipular cualquier equipo, considere los riesgos de la corriente eléctrica y familiarícese con los procedimientos estándar de prevención de accidentes. Al final de cada advertencia encontrará el número que le ayudará a encontrar el texto traducido en el apartado de traducciones que acompaña a este dispositivo.

GUARDE ESTAS INSTRUCCIONES

Varning! VIKTIGA SÄKERHETSANVISNINGAR

Denna varningssignal signalerar fara. Du befinner dig i en situation som kan leda till personskada. Innan du utför arbete på någon utrustning måste du vara medveten om farorna med elkretsar och känna till vanliga förfaranden för att förebygga olyckor. Använd det nummer som finns i slutet av varje varning för att hitta dess översättning i de översatta säkerhetsvarningar som medföljer denna anordning.

SPARA DESSA ANVISNINGAR**Figyelem FONTOS BIZTONSÁGI ELOÍRÁSOK**

Ez a figyelmeztető jel veszélyre utal. Sérülésveszélyt rejtő helyzetben van. Mielőtt bármely berendezésen munkát végezte, legyen figyelemmel az elektromos áramkörök okozta kockázatokra, és ismerkedjen meg a szokásos balesetvédelmi eljárásokkal. A kiadványban szereplő figyelmeztetések fordítása a készülékhez mellékelt biztonsági figyelmeztetések között található; a fordítás az egyes figyelmeztetések végén látható szám alapján kereshető meg.

ORIZZE MEG EZEKET AZ UTASÍTÁSOKAT!**Предупреждение ВАЖНЫЕ ИНСТРУКЦИИ ПО СОБЛЮДЕНИЮ ТЕХНИКИ БЕЗОПАСНОСТИ**

Этот символ предупреждения обозначает опасность. То есть имеет место ситуация, в которой следует опасаться телесных повреждений. Перед эксплуатацией оборудования выясните, каким опасностям может подвергаться пользователь при использовании электрических цепей, и ознакомьтесь с правилами техники безопасности для предотвращения возможных несчастных случаев. Воспользуйтесь номером заявления, приведенным в конце каждого предупреждения, чтобы найти его переведенный вариант в переводе предупреждений по безопасности, прилагаемом к данному устройству.

СОХРАНИТЕ ЭТИ ИНСТРУКЦИИ**警告 重要的安全性说明**

此警告符号代表危险。您正处于可能受到严重伤害的工作环境中。在您使用设备开始工作之前，必须充分意识到触电的危险，并熟练掌握防止事故发生的标准工作程序。请根据每项警告结尾提供的声明号码来找到此设备的安全性警告说明的翻译文本。

请保存这些安全性说明

警告 安全上の重要な注意事項

「危険」の意味です。人身事故を予防するための注意事項が記述されています。装置の取り扱い作業を行うときは、電気回路の危険性に注意し、一般的な事故防止策に留意してください。警告の各国語版は、各注意事項の番号を基に、装置に付属の「Translated Safety Warnings」を参照してください。

これらの注意事項を保管しておいてください。

주의 **중요 안전 지침**

이 경고 기호는 위험을 나타냅니다. 작업자가 신체 부상을 일으킬 수 있는 위험한 환경에 있습니다. 장비에 작업을 수행하기 전에 전기 회로와 관련된 위험을 숙지하고 표준 작업 관례를 숙지하여 사고를 방지하십시오. 각 경고의 마지막 부분에 있는 경고문 번호를 참조하여 이 장치와 함께 제공되는 번역된 안전 경고문에서 해당 번역문을 찾으십시오.

이 지시 사항을 보관하십시오.

Aviso **INSTRUÇÕES IMPORTANTES DE SEGURANÇA**

Este símbolo de aviso significa perigo. Você se encontra em uma situação em que há risco de lesões corporais. Antes de trabalhar com qualquer equipamento, esteja ciente dos riscos que envolvem os circuitos elétricos e familiarize-se com as práticas padrão de prevenção de acidentes. Use o número da declaração fornecido ao final de cada aviso para localizar sua tradução nos avisos de segurança traduzidos que acompanham o dispositivo.

GUARDE ESTAS INSTRUÇÕES**Advarsel** **VIGTIGE SIKKERHEDSANVISNINGER**

Dette advarselssymbol betyder fare. Du befinder dig i en situation med risiko for legemeskade. Før du begynder arbejde på udstyr, skal du være opmærksom på de involverede risici, der er ved elektriske kredsløb, og du skal sætte dig ind i standardprocedurer til undgåelse af ulykker. Brug erklæringsnummeret efter hver advarsel for at finde oversættelsen i de oversatte advarsler, der fulgte med denne enhed.

GEM DISSE ANVISNINGER**تحذير****إرشادات الأمان الهامة**

يوضح رمز التحذير هذا وجود خطر. وهذا يعني أنك متواجد في مكان قد ينتج عنه التعرض لإصابات. قبل بدء العمل، احذر مخاطر التعرض للصدمات الكهربائية وكن على علم بالإجراءات القياسية للحيلولة دون وقوع أي حوادث. استخدم رقم البيان الموجود في أحر كل تحذير لتحديد مكان ترجمته داخل تحذيرات الأمان المترجمة التي تأتي مع الجهاز. قم بحفظ هذه الإرشادات

Upozorenje **VAŽNE SIGURNOSNE NAPOMENE**

Ovaj simbol upozorenja predstavlja opasnost. Nalazite se u situaciji koja može prouzročiti tjelesne ozljede. Prije rada s bilo kojim uređajem, morate razumjeti opasnosti vezane uz električne sklopove, te biti upoznati sa standardnim načinima izbjegavanja nesreća. U prevedenim sigurnosnim upozorenjima, priloženima uz uređaj, možete prema broju koji se nalazi uz pojedino upozorenje pronaći i njegov prijevod.

SAČUVAJTE OVE UPUTE

Upozornění DŮLEŽITÉ BEZPEČNOSTNÍ POKYNY

Tento upozorňující symbol označuje nebezpečí. Jste v situaci, která by mohla způsobit nebezpečí úrazu. Před prací na jakémkoliv vybavení si uvědomte nebezpečí související s elektrickými obvody a seznamte se se standardními opatřeními pro předcházení úrazům. Podle čísla na konci každého upozornění vyhledejte jeho překlad v přeložených bezpečnostních upozorněních, která jsou přiložena k zařízení.

USCHOVEJTE TYTO POKYNY**Προειδοποίηση ΣΗΜΑΝΤΙΚΕΣ ΟΔΗΓΙΕΣ ΑΣΦΑΛΕΙΑΣ**

Αυτό το προειδοποιητικό σύμβολο σημαίνει κίνδυνο. Βρίσκεστε σε κατάσταση που μπορεί να προκαλέσει τραυματισμό. Πριν εργαστείτε σε οποιοδήποτε εξοπλισμό, να έχετε υπόψη σας τους κινδύνους που σχετίζονται με τα ηλεκτρικά κυκλώματα και να έχετε εξοικειωθεί με τις συνήθεις πρακτικές για την αποφυγή ατυχημάτων. Χρησιμοποιήστε τον αριθμό δήλωσης που παρέχεται στο τέλος κάθε προειδοποίησης, για να εντοπίσετε τη μετάφρασή της στις μεταφρασμένες προειδοποιήσεις ασφαλείας που συνοδεύουν τη συσκευή.

ΦΥΛΑΞΤΕ ΑΥΤΕΣ ΤΙΣ ΟΔΗΓΙΕΣ**אזהרה****הוראות בטיחות חשובות**

סימן אזהרה זה מסמל סכנה. אתה נמצא במצב העלול לגרום לפציעה. לפני שתעבוד עם ציוד כלשהו, עליך להיות מודע לסכנות הכרוכות במגעלים חשמליים ולהכיר את הנהלים המקובלים למניעת תאונות. השתמש במספר ההוראה המסופק בסופה של כל אזהרה כדי לאתר את התרגום באזהרות הבטיחות המתורגמות שמצורפות להתקן.

שמור הוראות אלה**ВАЖНИ БЕЗБЕДНОСНИ НАПАТСТВИЈА**

Симболот за предупредување значи опасност. Се наоѓате во ситуација што може да предизвика телесни повреди. Пред да работите со опремата, бидете свесни за ризикот што постои кај електричните кола и треба да ги познавате стандардните постапки за спречување на несреќни случаи. Искористете го бројот на изјавата што се наоѓа на крајот на секое предупредување за да го најдете неговиот период во преведените безбедносни предупредувања што се испорачани со уредот.

ЧУВАЈТЕ ГИ ОБИЕ НАПАТСТВИЈА**Ostrzeżenie WAŻNE INSTRUKCJE DOTYCZĄCE BEZPIECZEŃSTWA**

Ten symbol ostrzeżenia oznacza niebezpieczeństwo. Zachodzi sytuacja, która może powodować obrażenia ciała. Przed przystąpieniem do prac przy urządzeniach należy zapoznać się z zagrożeniami związanymi z układami elektrycznymi oraz ze standardowymi środkami zapobiegania wypadkom. Na końcu każdego ostrzeżenia podano numer, na podstawie którego można odszukać tłumaczenie tego ostrzeżenia w dołączonym do urządzenia dokumencie z tłumaczeniami ostrzeżeń.

NINIEJSZE INSTRUKCJE NALEŻY ZACHOWAĆ

Upozornenie DŮLEŽITÉ BEZPEČNOSTNÉ POKYNY

Tento varovný symbol označuje nebezpečenstvo. Nachádzate sa v situácii s nebezpečenstvom úrazu. Pred prácou na akomkoľvek vybavení si uvedomte nebezpečenstvo súvisiace s elektrickými obvodmi a oboznámte sa so štandardnými opatreniami na predchádzanie úrazom. Podľa čísla na konci každého upozornenia vyhľadajte jeho preklad v preložených bezpečnostných upozorneniach, ktoré sú priložené k zariadeniu.

USCHOVAJTE SI TENTO NÁVOD**Opozorilo POMEMBNI VARNOSTNI NAPOTKI**

Ta opozorilni simbol pomeni nevarnost. Nahajate se v situaciji, kjer lahko pride do telesnih poškodb. Preden pričnete z delom na napravi, se morate zavedati nevarnosti udara električnega toka, ter tudi poznati preventivne ukrepe za preprečevanje takšnih nevarnosti. Uporabite obrazložitevno številko na koncu posameznega opozorila, da najdete opis nevarnosti v priloženem varnostnem priložniku.

SHRANITE TE NAPOTKE!**警告****重要安全性指示**

此警告符號代表危險，表示可能造成人身傷害。使用任何設備前，請留心電路相關危險，並熟悉避免意外的標準作法。您可以使用每項警告後的聲明編號，查詢本裝置隨附之安全性警告譯文中的翻譯。請妥善保留此指示

Related Documentation

The Cisco IOS software running your Cisco Voice Gateway includes extensive features and functionality. For information that is beyond the scope of this document, or for additional information, use the resources listed in [Table 3](#).



Timesaver

Make sure that you have access to the documents listed in [Table 3](#). See the “[Obtaining Documentation](#)” section on page xv for information about obtaining these documents.

Table 3 **Related and Referenced Documents**

| Cisco Product | Document Title |
|---------------------------------|--|
| Cisco VG350 Voice Gateway | <ul style="list-style-type: none"> • <i>Cisco VG350 Voice Gateway Hardware Installation Guide</i> (this book) • Cisco VG350 Voice Gateway Software Configuration Guide • Cisco VG350 Voice Gateway Regulatory Compliance and Safety Information |
| Cisco IOS software ¹ | <ul style="list-style-type: none"> • Release 15.2(4)M New Features and Important Notes |

1. Refer to the modular reference publications that correspond to the Cisco IOS software release installed on your Cisco VG350 Voice Gateway.

Obtaining Documentation

Cisco documentation and additional literature are available on Cisco.com. Cisco also provides several ways to obtain technical assistance and other technical resources. These sections explain how to obtain technical information from Cisco Systems.

Cisco.com

You can access the most current Cisco documentation at this URL:

<http://www.cisco.com/univercd/home/home.htm>

You can access the Cisco website at this URL:

<http://www.cisco.com>

You can access international Cisco websites at this URL:

http://www.cisco.com/public/countries_languages.shtml

Ordering Documentation

You can find instructions for ordering documentation at this URL:

http://www.cisco.com/univercd/cc/td/doc/es_inpk/pdi.htm

You can order Cisco documentation in these ways:

- Registered Cisco.com users (Cisco direct customers) can order Cisco product documentation from the Ordering tool:

<http://www.cisco.com/en/US/partner/ordering/index.shtml>

- Nonregistered Cisco.com users can order documentation through a local account representative by calling Cisco Systems Corporate Headquarters (California, USA) at 408 526-7208 or, elsewhere in North America, by calling 800 553-NETS (6387).

Documentation Feedback

You can send comments about technical documentation to bug-doc@cisco.com.

You can submit comments by using the response card (if present) behind the front cover of your document or by writing to the following address:

Cisco Systems
Attn: Customer Document Ordering
170 West Tasman Drive
San Jose, CA 95134-9883

We appreciate your comments.

Obtaining Technical Assistance

For all customers, partners, resellers, and distributors who hold valid Cisco service contracts, Cisco Technical Support provides 24-hour-a-day, award-winning technical assistance. The Cisco Technical Support Website on Cisco.com features extensive online support resources. In addition, Cisco Technical Assistance Center (TAC) engineers provide telephone support. If you do not hold a valid Cisco service contract, contact your reseller.

Cisco Technical Support Website

The Cisco Technical Support Website provides online documents and tools for troubleshooting and resolving technical issues with Cisco products and technologies. The website is available 24 hours a day, 365 days a year at this URL:

<http://www.cisco.com/techsupport>

Access to all tools on the Cisco Technical Support Website requires a Cisco.com user ID and password. If you have a valid service contract but do not have a user ID or password, you can register at this URL:

<http://tools.cisco.com/RPF/register/register.do>

Submitting a Service Request

Using the online TAC Service Request Tool is the fastest way to open S3 and S4 service requests. (S3 and S4 service requests are those in which your network is minimally impaired or for which you require product information.) After you describe your situation, the TAC Service Request Tool automatically provides recommended solutions. If your issue is not resolved using the recommended resources, your service request will be assigned to a Cisco TAC engineer. The TAC Service Request Tool is located at this URL:

<http://www.cisco.com/techsupport/servicerequest>

For S1 or S2 service requests or if you do not have Internet access, contact the Cisco TAC by telephone. (S1 or S2 service requests are those in which your production network is down or severely degraded.) Cisco TAC engineers are assigned immediately to S1 and S2 service requests to help keep your business operations running smoothly.

To open a service request by telephone, use one of the following numbers:

Asia-Pacific: +61 2 8446 7411 (Australia: 1 800 805 227)

EMEA: +32 2 704 55 55

USA: 1 800 553 2447

For a complete list of Cisco TAC contacts, go to this URL:

<http://www.cisco.com/techsupport/contacts>

Definitions of Service Request Severity

To ensure that all service requests are reported in a standard format, Cisco has established severity definitions.

Severity 1 (S1)—Your network is “down,” or there is a critical impact to your business operations. You and Cisco will commit all necessary resources around the clock to resolve the situation.

Severity 2 (S2)—Operation of an existing network is severely degraded, or significant aspects of your business operation are negatively affected by inadequate performance of Cisco products. You and Cisco will commit full-time resources during normal business hours to resolve the situation.

Severity 3 (S3)—Operational performance of your network is impaired, but most business operations remain functional. You and Cisco will commit resources during normal business hours to restore service to satisfactory levels.

Severity 4 (S4)—You require information or assistance with Cisco product capabilities, installation, or configuration. There is little or no effect on your business operations.

Obtaining Additional Publications and Information

Information about Cisco products, technologies, and network solutions is available from various online and printed sources.

- Cisco Marketplace provides a variety of Cisco books, reference guides, and logo merchandise. Visit Cisco Marketplace, the company store, at this URL:

<http://www.cisco.com/go/marketplace/>

- The Cisco *Product Catalog* describes the networking products offered by Cisco Systems, as well as ordering and customer support services. Access the Cisco Product Catalog at this URL:

<http://cisco.com/univercd/cc/td/doc/pcat/>

- *Cisco Press* publishes a wide range of general networking, training and certification titles. Both new and experienced users will benefit from these publications. For current Cisco Press titles and other information, go to Cisco Press at this URL:

<http://www.ciscopress.com>

- *Packet* magazine is the Cisco Systems technical user magazine for maximizing Internet and networking investments. Each quarter, Packet delivers coverage of the latest industry trends, technology breakthroughs, and Cisco products and solutions, as well as network deployment and troubleshooting tips, configuration examples, customer case studies, certification and training information, and links to scores of in-depth online resources. You can access Packet magazine at this URL:

<http://www.cisco.com/packet>

- *Internet Protocol Journal* is a quarterly journal published by Cisco Systems for engineering professionals involved in designing, developing, and operating public and private internets and intranets. You can access the Internet Protocol Journal at this URL:

<http://www.cisco.com/ipj>

- World-class networking training is available from Cisco. You can view current offerings at this URL:

<http://www.cisco.com/en/US/learning/index.html>



CHAPTER 1

Overview of the Cisco VG350 Voice Gateway

This chapter provides a brief description of the Cisco VG350 Voice Gateway (VG) and contains the following sections:

- [Overview, page 1-1](#)
- [VG350 Voice Gateway Chassis, page 1-2](#)
- [Interfaces and Service Capabilities, page 1-3](#)
- [Physical Description and LEDs, page 1-4](#)
- [Software Elements, page 1-9](#)

Overview

The Cisco VG350 service module is a high-density analog voice gateway. It is an intermediate path that enables TDM to IP transition.

The Cisco VG350 Voice Gateway supports the following interfaces:

- Gigabit Ethernet (GE)
- USB
- High-Speed WAN Interface Card (HWIC) and Voice/WAN Interface Card (VWIC)
- Double-Wide Service Module (DWSM) interface



Warning

This unit is intended for installation in restricted access areas. A restricted access area can be accessed only through the use of a special tool, lock and key, or other means by security.

Statement 1017

VG350 Voice Gateway Chassis

The following figures show the front and back panels of the VG350 Voice Gateway Chassis:

- [Figure 1-1](#) shows the Front Panel.
- [Figure 1-2](#) shows the Back Panel.

Figure 1-1 Front Panel of the VG350 Voice Gateway

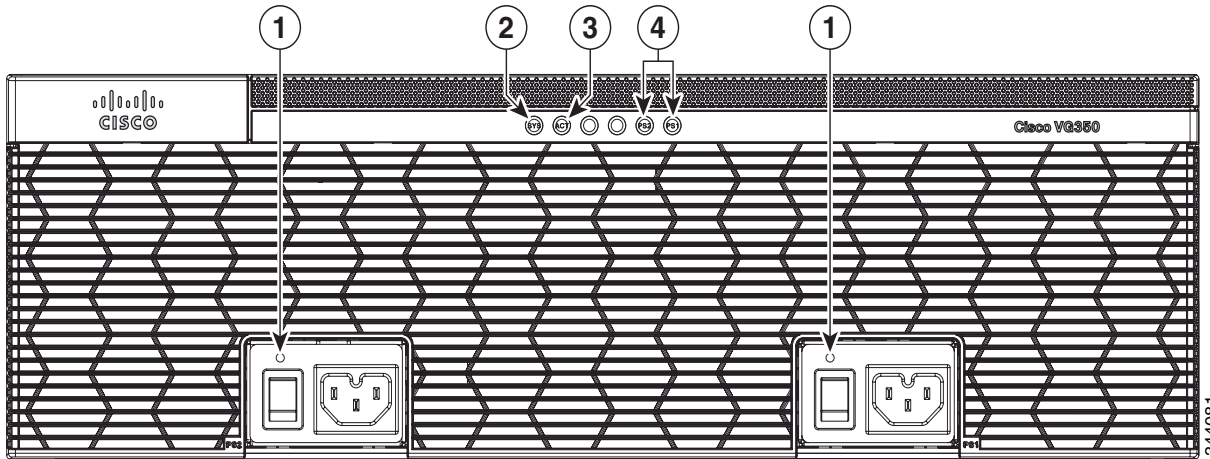

| | | | |
|---|--------------------|---|-------------------------|
| 1 | AC OK ¹ | 3 | ACT status LED |
| 2 | SYS status LED | 4 | PS1 (Right), PS2 (Left) |

1. LED goes off if the AC power fails or is disconnected. It does not go on and off with the power switch.

Figure 1-2 Back Panel of the VG350 Voice Gateway

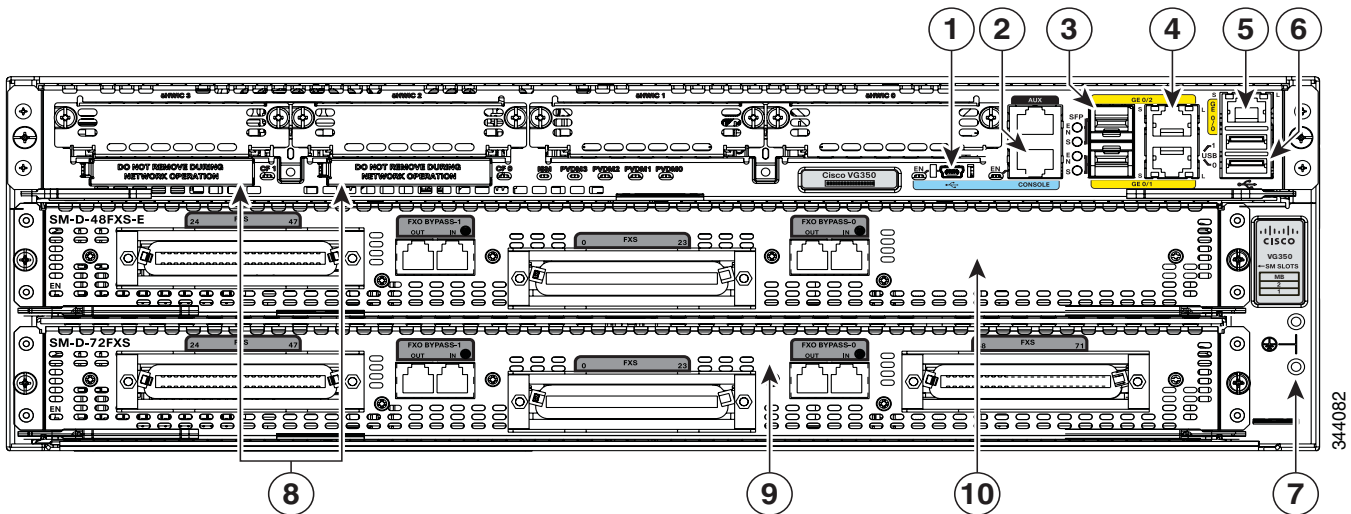

| | | | |
|----------|---|-----------|-------------------------------------|
| 1 | USB serial console port | 6 | USB0 and USB1 (1, Top) |
| 2 | RJ-45 serial console port | 7 | Ground |
| 3 | SFP1 and SFP2 (2, Top) | 8 | CompactFlash 0 and 1 (0, Far right) |
| 4 | 10/100/1000 Ethernet ports GE 0/1 and GE 0/2 (GE 0/2,Top) | 9 | SM-D-72FXS Service Module |
| 5 | 10/100/1000 Ethernet port GE 0/0 | 10 | SM-D-48FXS-E Service Module |

Configuration Options

The following configuration options are available for Cisco VG350 Voice Gateway:

Table 1-1 Configuration Options Possible with Cisco VG350 Voice Gateway with the Double-Wide High Density Analog Service Module (DWSM)

| Configuration | VG350 | | |
|---------------|--------------|--------------|-----------------------|
| | SM 1 | SM 2 | Total number of ports |
| 1 | SM-D-72FXS | SM-D-72FXS | 144 |
| 2 | SM-D-72FXS | SM-D-48FXS-E | 120 |
| 4 | SM-D-48FXS-E | SM-D-48FXS-E | 96 |

Interfaces and Service Capabilities

Table 1-2 lists the built-in interface ports for the Cisco VG350.

Table 1-2 Built-in Interfaces for the Cisco VG350

| | Data Ports | | | Management Ports | | |
|---------------------------|----------------------|-----------------|------------|-----------------------|-----------------------------------|------------------|
| | 10/100/1000 GE RJ-45 | 10/100/1000 SFP | USB Type A | Console Serial, RJ-45 | Console Serial, Mini-USB (Type B) | Auxiliary, RJ-45 |
| Cisco VG350 Voice Gateway | 3 ¹ | 2 | 2 | 1 | 1 | 1 |

1. One RJ-45 with two GE SFPs or three RJ-45 GEs.

Physical Description and LEDs

LED Indicators

Table 1-3 describes the LED indicators for the Cisco VG350.

Table 1-3 LED Indicators for Cisco VG350

| LED | Color | Description | Location on the VG350 |
|-----------|-------------------------|---|-----------------------|
| PS/PS1 | Green | System is running. | Front bezel |
| | Amber | System is not running. | |
| PS2 | Green | System is running. | Front bezel |
| | Amber | System is not running. | |
| AC OK | Green | AC power connected. | Front bezel |
| | Off | No AC power connected | |
| RPS | Green | System is running on external RPS power supply. | — |
| SYS | Solid green | Solid green indicates normal operation. | Front bezel |
| | Blinking green | System is booting or is in ROM monitor mode. | |
| | Amber | System error. | |
| | Off | Power is off or system board is faulty. | |
| ACT | Solid or blinking green | Solid or blinking indicates packet activity between the forwarding and routing engine and any I/O port. | Front bezel |
| | Off | No packet transfers are occurring. | |
| RJ-45 CON | Green | Serial console is active. | Back panel |
| USB CON | Green | USB console is active. | Back panel |
| GE: Link | Green | Solid green indicates the Ethernet port has a link partner. | Back panel |
| SFP S | Blinking green | Blinking frequency indicates port speed. See the definition for the S LED. | Back panel |
| SFP EN | Off | Not present. | Back panel |
| | Green | Present and enabled. | |
| | Amber | Present with failure. | |

Table 1-3 LED Indicators for Cisco VG350 (continued)

| LED | Color | Description | Location on the VG350 |
|-------------------|-------|---|-----------------------|
| CF0/CF1 | Green | Flash memory is being accessed; do not eject the CompactFlash memory card. | Back panel |
| | Amber | CompactFlash error. | |
| | Off | Flash memory is not being accessed; okay to eject the CompactFlash memory card. | |
| | Off | No FE or GE link is established. | |
| PVDM 0,1,2, and 3 | Green | PVDM is initialized. | Back panel |
| | Amber | PVDM is detected but not initialized. | |
| | Off | No PVDM installed. | |

Specifications

Table 1-4 details the technical specifications of the Cisco VG350 Voice Gateway.

Table 1-4 Cisco VG350 Voice Gateway Technical Specifications

| Description | Specification |
|---|---|
| Physical | |
| Dimensions (H x W x D) | 5.22 x 17.25 x 18.75 in. (88.9 x 438.2 x 476.2 mm), 3 RU height |
| Weight with AC PS (without modules) | 39 lbs (17.69 kg) |
| Weight with AC PS (without modules) | 40 lbs (18.14 kg) |
| Weight (fully configured) | 60 lbs (27.21 kg) |
| Power | |
| AC input power | |
| • Input voltage | 100 to 240 VAC, autoranging |
| • Frequency | 47 to 63 Hz |
| • Input current | 0.4 to 3.5 A (configuration dependent) |
| • Input current with AC | 0.4 to 7.0 A (configuration dependent) |
| • Surge current | 30 A maximum at 115 VAC 60 Hz 60 A maximum at 230 VAC 50 Hz |
| Power consumption | 85 to 400 W, 600 to 1370 BTU/hr (configuration dependent) |
| With AC | 85 to 800 W, 600 to 2740 BTU/hr (configuration dependent) |
| Ports | |
| Console port | One RJ-45 connector and one mini USB Type B, USB 2.0 compliant |
| Auxiliary port | RJ-45 connector |
| USB ports | Two USB Type A, USB 2.0 compliant, 2.5 W (500 mA) maximum ¹ |
| 10/100/1000 Gigabit Ethernet | Three RJ-45 connectors (GE 0/0, GE 0/1, GE 0/2) auto-MDIX2 |
| SFP | Two RJ-45 connectors support SFP modules. When an SFP module is installed, the adjacent RJ-45 GE connector is disabled. |
| Environmental | |
| Operating humidity | 5 to 85%, noncondensing |
| Operating humidity (short-term per NEBS) | 5% to 90%, but not to exceed 0.024 kg water/kg of dry air |
| Operating temperature up to 5906 ft (1800 m) elevation | 32 to 104°F (0 to 40°C) |
| Operating temperature up to 9843 ft (3000 m) elevation | 32 to 104°F (0 to 40°C) |
| Operating temperature up to 13,123 ft (4000 m) elevation | 32 to 86°F (0 to 30°C) |

Table 1-4 Cisco VG350 Voice Gateway Technical Specifications (continued)

| Description | Specification |
|---|--|
| Temperature (short-term per NEBS/1800m max altitude) | 23 to 122°F (−5°C to 50°C) |
| Operating altitude maximum | 13,123 ft (4000 m) |
| |  Note For China, the unit cannot operate above 2000 m. The internal AC power supplies do not meet the new Chinese Safety requirements for products that operate in the 2001-5000 m range. |
| Transportation and Storage | |
| Non-operating temperature | −40 to 158°F (−40 to 70°C) |
| Non-operating humidity | 5 to 95% RH |
| Non-operating altitude | 15,000 ft (4570 m) |
| Acoustic | |
| Acoustic: Sound Pressure (Typical/Maximum) | 57.6 to 77.6 dBA |
| Acoustic: Sound Power (Typical/Maximum) | 67.8 to 84.7 dBA |
| Compliance | |
| Safety compliance | <ul style="list-style-type: none"> • IEC 60950-1, Safety of information technology equipment • EN 60950-1, Safety of information technology equipment • UL 60950-1, Standard for safety for information technology equipment [US] • CAN/CSA C22.2 No. 60950-1, Safety of information technology equipment including electrical business equipment [Canada] • AS/NZS 60950.1 2003 • IEC60950, 3rd edition [PRC] • IEC60950, 2nd Edition [Mexico] |

Table 1-4 Cisco VG350 Voice Gateway Technical Specifications (continued)

| Description | Specification |
|---------------------|--|
| Immunity compliance | <ul style="list-style-type: none"> • CISPR24 ITE-Immunity characteristics, Limits and methods of measurement • EN 55024 ITE-Immunity characteristics, Limits and methods of measurement • EN 50082-1 Electromagnetic compatibility - Generic immunity standard - Part 1 • EN 300-386 Electromagnetic compatibility for TNESD/EMI • EN 61000-6-1 • SD/EMI |
| EMC compliance | <ul style="list-style-type: none"> • EN 55022, Class A • CISPR22, Class A • CFR47, Part 15, Subpart B, Class A • EN300386, Class A • AS/NZS CISPR22, Class A • VCCI, Class A • SD/EMI, Class A • Harmonic Current Emission <ul style="list-style-type: none"> – EN 61000-3-2 for EUT Power requirements <16A – EN 61000-3-12 for EUT Power requirements >16A • Voltage Fluctuation and Flicker <ul style="list-style-type: none"> – EN 61000-3-3 for EUT Power requirements <16 – EN 61000-3-11 for EUT Power requirements >16A |

1. 480 Mb/s individually, bandwidth is shared when both are used.

**Warning**

Ultimate disposal of this product should be handled according to all national laws and regulations.
Statement 1040

Software Elements

The operating system for the Cisco VG350 Voice Gateway is the Cisco IOS software that resides in flash memory.

Configuration Connections

You can use an ASCII terminal or a PC to configure a Cisco VG350 Voice Gateway. The configuration can be performed in several ways:

- Locally, with a direct connection through the console port
- Remotely, with a connection through the auxiliary port and a modem
- Through Telnet and TFTP

Configuration Methods

Automated Configuration

If your Cisco VG350 Voice Gateway was ordered with the Simple Network-Enabled Auto-Provision (SNAP) option, no onsite configuration is required. When the Cisco VG350 Voice Gateway is powered on and connected, the SNAP application downloads the applicable configuration files automatically.

Manual Configuration

When a Cisco VG350 Voice Gateway is first installed, use the procedure in the [“Power-On Procedure” section on page 5-1](#) for the initial configuration. This sets the basic communication parameters.

After the Cisco VG350 Voice Gateway is operating and able to communicate, use the procedures in [Cisco VG350 Voice Gateway Software Configuration Guide](#) to configure the specific services and functions or to make changes to the existing configuration.

There are multiple methods for configuring a Cisco VG350 Voice Gateway:

- System configuration dialog
- Configuration mode—Cisco IOS software CLI
- setup command facility—Remote configuration through a LAN
- SNMP-based application—CiscoView or HP OpenView
- HTTP-based configuration server—Provides access to the CLI from a web browser



CHAPTER 2

Cisco Double-Wide High Density Analog Service Modules

This chapter provides information about the following Double-Wide High Density Analog Service Module (DWSM).

1. Cisco SM-D-72FXS Service Module—A 72 FXS port DWSM with 4 out of the 72 ports supporting OPX 'Lite' capabilities.
2. Cisco SM-D-48FXS-E Service Module—A 48 FXS port DWSM with all 48 ports supporting OPX Lite capabilities.



Note

DWSM refers to both the Cisco SM-D-72FXS and SM-D-48FXS-E Service Module.

This chapter contains the following sections:

- [Double-Wide High Density Analog Service Module Overview, page 2-2](#)
- [FXO Fail-Over Bypass Ports, page 2-5](#)
- [Cisco SM-D-72FXS Service Module Specifications, page 2-6](#)
- [Cisco SM-D-48FXS-E Service Module Specifications, page 2-6](#)
- [Port Numbering Conventions, page 2-7](#)
- [Connecting to the Double-Wide High Density Service Module Ports, page 2-7](#)
- [Online Insertion and Removal, page 2-7](#)

Double-Wide High Density Analog Service Module Overview

The Double-Wide High Density Service Module (DWSM) is supported on the following platforms:

- Cisco 3945
- Cisco 3945e
- Cisco 3925
- Cisco 3925e
- Cisco 2951

The modules can be plugged in the following DWSM slots of the following platforms:

- On Cisco 3945 and Cisco 3945e - only on slot 4.
- On Cisco 3925, Cisco 3925e and Cisco 2951 - only on slot 2.

Table 2-1 shows the comparison between Cisco SM-D-72FXS and SM-D-48FXS-E.

Table 2-1 Feature comparison of SM-D-72FXS and SM-D-48FXS-E

| | SM-D-72FXS | SM-D-48FXS-E |
|---------------------------------------|--|--|
| Number of FXS Ports | 72 (Port 0 to Port 71) | 48 (Port 0 to Port 47) |
| Number of Ports Configurable as FXS-E | 4 (Port 0 to Port 3) | 48 (all ports) |
| Max RENs/Port | 5 REN/FXS Port 2 REN/FXS-E Port | 5 REN/FXS Port 2 REN/FXS-E Port |
| Total REN Per DWSM Module | 40 | 30 |
| RJ-21 Connectors | 3 | 2 |
| FXO Bypass Ports ¹ | 2 (FXO Bypass Port 0: PSTN to Port 46) FXO Bypass Port 1: PSTN to Port 47) | 2 (FXO Bypass Port 0: PSTN to Port 46) FXO Bypass Port 1: PSTN to Port 47) |

1. Each FXO Bypass Port are made up of two RJ-11 connectors for PSTN In and Out.

Installing SM-D-72FXS

Install the SM-D-72FXS according to the instructions in the [Installing Cisco Interface Cards in Cisco Access Routers](#) document.

Grounding

Ensure that the equipment you are working with is properly grounded according to the instructions in the [Installing Cisco Interface Cards in Cisco Access Routers](#) document.

Cables

The VG350 Voice Gateway uses RJ-21 cables to connect to a distribution box.



To avoid electric shock, do not connect safety extra-low voltage (SELV) circuits to telephone-network voltage (TNV) circuits. LAN ports contain SELV circuits, and WAN ports contain TNV circuits. Some LAN and WAN ports both use RJ-45 connectors. Use caution when connecting cables. Statement 1021



Hazardous network voltages are present in WAN ports regardless of whether power to the unit is OFF or ON. To avoid electric shock, use caution when working near WAN ports. When detaching cables, detach the end away from the unit first. Statement 1026



This equipment contains a ring signal generator (ringer), which is a source of hazardous voltage. Do not touch the RJ-11 (phone) port wires (conductors), the conductors of a cable connected to the RJ-11 port, or the associated circuit-board when the ringer is active. The ringer is activated by an incoming call. Statement 1042



For connections outside the building where the equipment is installed, the following ports must be connected through an approved network termination unit with integral circuit protection: FXS. Statement 1044

Connecting SM-D-72FXS

To connect the SM-D-72FXS, follow the these steps:

- Step 1** Confirm that the router is turned off.
- Step 2** Connect one end of the straight-through RJ-21 cable to an RJ-21 distribution box.
- Step 3** Connect the distribution box ports to a telephone or FAX machine using RJ-11 cable.
- Step 4** Power up the router.

Installing SM-D-48FXS-E

Install the SM-D-72FXS according to the instructions in the *Installing Cisco Interface Cards in Cisco Access Routers* document.

Grounding

Ensure that the equipment you are working with is properly grounded according to the instructions in the *Installing Cisco Interface Cards in Cisco Access Routers* document.

Cables

The VG350 Voice Gateway uses RJ-21 cables to connect to a distribution box.



Warning

To avoid electric shock, do not connect safety extra-low voltage (SELV) circuits to telephone-network voltage (TNV) circuits. LAN ports contain SELV circuits, and WAN ports contain TNV circuits. Some LAN and WAN ports both use RJ-45 connectors. Use caution when connecting cables. Statement 1021



Warning

Hazardous network voltages are present in WAN ports regardless of whether power to the unit is OFF or ON. To avoid electric shock, use caution when working near WAN ports. When detaching cables, detach the end away from the unit first. Statement 1026



Warning

This equipment contains a ring signal generator (ringer), which is a source of hazardous voltage. Do not touch the RJ-11 (phone) port wires (conductors), the conductors of a cable connected to the RJ-11 port, or the associated circuit-board when the ringer is active. The ringer is activated by an incoming call. Statement 1042



Warning

For connections outside the building where the equipment is installed, the following ports must be connected through an approved network termination unit with integral circuit protection: FXS. Statement 1044

Connecting SM-D-48FXS-E

To connect the SM-D-48FXS-E, follow the these steps:

- Step 1** Confirm that the router is turned off.
- Step 2** Connect one end of the straight-through RJ-21 cable to an RJ-21 distribution box.
- Step 3** Connect the distribution box ports to a telephone or FAX machine using an RJ-11 cable.
- Step 4** Power up the router.

FXO Fail-Over Bypass Ports

Bypass/Failover Port, also called Fail-over Trunk Bypass, provides a way to use designated analog phone ports to make phone calls through the Public Switch Telephone Network (PSTN) during power-outage or power savings circumstances.

Table 2-2 shows the RJ-11 connector assignment.

Table 2-2 RJ-11 Connector Assignment

| Faceplate Label | IN (RJ-11) | OUT (RJ-11) | Power ON | Power OFF |
|------------------------|-------------------|--------------------------------------|--|--|
| FXO BYPASS-0 | To PSTN | To external FXO Interface (optional) | PSTN to external FXO Interface FXS Port 46 to RJ-21 connector | PSTN to RJ-21 connector Port 46 No connection to external FXO I/F |
| FXO BYPASS-1 | To PSTN | To external FXO Interface (optional) | PSTN to external FXO Interface FXS Port 47 to RJ-21 connector | PSTN to RJ-21 connector Port 47 No connection to external FXO I/F |

Cisco SM-D-72FXS Service Module Specifications

Physical Description and LEDs

All interface ports and LEDs are on the rear of the chassis. [Figure 2-1](#) illustrates their locations.

Figure 2-1 Cisco SM-D-72FXS Service Module LEDs

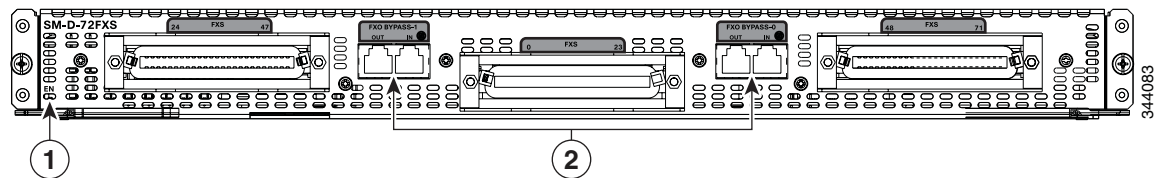

| | | | |
|---|--------|---|------------------|
| 1 | EN LED | 2 | FXO Bypass ports |
|---|--------|---|------------------|

Cisco SM-D-48FXS-E Service Module Specifications

Physical Description and LEDs

All interface ports and LEDs are on the rear of the chassis. [Figure 2-2](#) illustrates their locations.

Figure 2-2 Cisco SM-D-48FXS-E Service Module LEDs

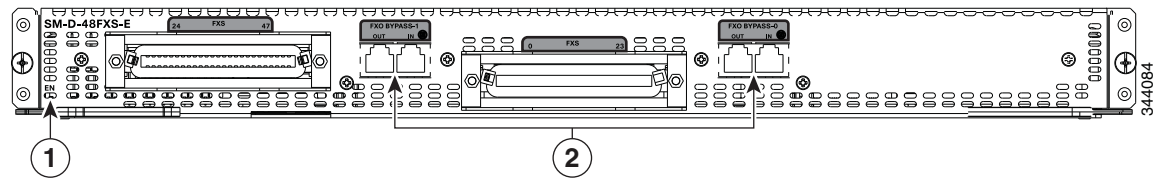

| | | | |
|---|--------|---|------------------|
| 1 | EN LED | 2 | FXO Bypass ports |
|---|--------|---|------------------|

Port Numbering Conventions

Port numbering conventions for the Cisco VG350 Voice Gateway are as follows:

- Two Compact Flash slots, CF0 and CF1.
- GE ports are 10/100/1000 BASE-T, numbered GE 0/0 through GE 0/2.
- 10/100BASE-T ports are numbered 10/100BASE-T 0/0 and 10/100BASE-T 0/1 from right to left.
- FXS voice port numbering begins at 2/0/0 to 2/0/71 or 2/0/47 and 4/0/0 to 4/0/71 or 4/0/47, depending on the number of voice ports.

The ports numbered 2/0/x are for the SM installed in slot 1 and the ports numbered 4/0/x are for the Service Module (SM) installed in slot 2.

Connecting to the Double-Wide High Density Service Module Ports

Three RJ-21 female connectors are available on the SM-D-72FXS service module. The middle RJ-21 connector accesses FXS ports 0 to 23, the left RJ-21 female connector accesses ports 24 to 4, and the right RJ-21 connector accesses ports 48 to 71. Use RJ-21 male connector to connect from the DWSM RJ-21 ports to an FXS port RJ-11 distribution box.

**Note**

Use an RJ-21 cable with Amphenol 50-pin connectors.

Online Insertion and Removal

The DWSM can be hot-inserted into the VG350 Voice Gateway without any potential of electrical damage either to the SM or the Host because the Online Insertion and Removal (OIR) logic is present on all SM designs.

OIR1 is the ability to insert and remove an SM while the system is running without causing electrical damage to the SM or Host and without interfering with the operation of any other modules or portions of a running system.

The basic feature for OIR support on an SM is the control and isolation of the 12V power rail via a field-effect transistor (FET). This FET is enabled in a controlled fashion after the SM card is fully inserted.

Insertion and Removal Steps

This section describes the sequence of steps when inserting or removing a DWSM. OIR can only be done on one service module at a time. It only supports the same service module type. If you remove an SM-D-72FXS, only another SM-D-72FXS can be inserted.

Insertion

The following steps show how to insert a service module.

1. Insert the service module into the slot.
2. Make sure that the following message is displayed:

```
*Apr 19 00:14:19.177: %LINK-3-UPDOWN: Interface Foreign Exchange Station x/y/z,
changed state to up
```

**Note**

There are about 72 or 48 messages being displayed so it may take some time for the message to appear. Estimated waiting time is approximately 2 minutes.

3. Use the following command to verify the voice ports after insertion.

show voice port summary

Removal

The following steps show how to remove a service module.

1. Ensure there is no active call on the service module that you want to remove.

Use the following command to find any active call in the system:

show voice call status

2. Use the following command to proceed:

hw-module sm x oir-stop

where *x* is the slot number of the Service Module

3. Wait until the following message is displayed:

```
SM Hardware slot 2 can be removed
```

4. Remove the service module from its slot.

EN LED

Each Service Module(SM) has an Enable LED that is mounted on the SM and visible through the faceplate of the SM. The EN LED includes:

- Green / Amber Dual Color LED
- Defaults to OFF / ON power up



CHAPTER 3

Planning Your Installation

Before you install your Cisco VG350 Voice Gateway, consider the information in this chapter:

- [Location and Mounting Requirements, page 3-1](#)
- [Distance Limitations for Interface Cables, page 3-4](#)
- [Interference Considerations, page 3-5](#)

Location and Mounting Requirements

The three mounting possibilities for your Cisco VG350 Voice Gateway are as follows:

- Rack-mount
- Wall-mount
- Bench-top

The mounting location must provide the following:

- Access to the chassis
- Access to a suitable power source
- Access to an appropriate earth ground
- Allowance for adequate heat dissipation and airflow around the chassis

Temperature Control and Ventilation

The installation location (room, closet, or cabinet) for the Cisco VG350 Voice Gateway should always be well ventilated and provide adequate air circulation to ensure proper cooling. The room temperature should be maintained between 32 to 122°F (0 to 50°C).



Note

The Cisco VG350 Voice Gateway chassis is designed for back and sides-to-front airflow.

Enclosed Racks

**Caution**

Enclosed racks must have adequate ventilation. An enclosed rack should never be overcrowded and should have louvers and a fan.

If the Cisco VG350 Voice Gateway is installed in an enclosed rack with a ventilation fan at the top, make sure that heated air drawn upward from other equipment does not prevent adequate cooling.

If the chassis is installed using slide rails, check for blocked ventilation ports when it is in position in the rack or cabinet. Make sure that the ventilation ports of the Cisco VG350 Voice Gateway are not blocked.

**Tip**

Baffles can help isolate exhaust air from intake air. Baffles also help draw cooling air through the cabinet. The best location for the baffles depends on the airflow patterns in the rack. You can test the airflow by experimenting with different equipment arrangements.

Bench-Mounted

If the unit is placed on a bench-top, do not stack other equipment or paper on the chassis. Provide plenty of space for air circulation (front to back). Inadequate ventilation can result in overheating and damage.

Access to Chassis

Allow space at the rear of the chassis for cable connections. Also consider the need to access the chassis for future upgrades, maintenance, and troubleshooting.

Chassis Grounding

Chassis grounding is provided through the power cable, which uses a standard grounding plug. However, the chassis also requires a reliable earth ground using the earth ground lug and hardware provided.

Power Source

A Cisco VG350 Voice Gateway with AC power supply autoselects either 100–127 volt or 200–240 volt operation. AC versions include a 6-foot (1.8-meter) electrical power cord. (A label near the power cord indicates the correct voltage, frequency, current draw, and power dissipation.)

Power Supply Considerations

Cisco VG350 Voice Gateway requires significantly more power because of its high-density ports and OPX 'Lite' requirements.

This require a larger 48V battery backup that may need to be custom built.

To handle power failure conditions, an uninterruptured power supply (UPS) is needed. UPS is widely available in all markets, including emerging markets (due to prevalence of UPS for personal computers). Thus, a separate UPS for Cisco VG350 Voice Gateway is a viable option when the ISR/UPS is not co-located with it.

If you suspect that your AC power is not clean—if lights flicker often or there is machinery with large motors nearby—have a qualified person test the power. Install a power conditioner if necessary.



Do not work on the system or connect or disconnect cables during periods of lightning activity. Statement 1001



Read the installation instructions before you connect the system to its power source. Statement 1004



This product relies on the building's installation for short-circuit (overcurrent) protection. Ensure that the protective device is rated not greater than: 120 VAC, 15A U.S. (240 VAC, 10A international) Statement 1005



The device is designed for connection to TN and IT power systems. Statement 1007



This unit is intended for installation in restricted access areas. A restricted access area can be accessed only through the use of a special tool, lock and key, or other means by security. Statement 1017

Cable Types

The cable types that are used are dependent on the Cisco VG350 Voice Gateway that you are using. For more information, see the [“Interfaces and Service Capabilities”](#) section on page 1-3 and [“Cable Specifications and Information”](#) section on page A-1.

- GE cables (RJ-45 to RJ-45 straight-through cables)
- Analog voice cables (RJ-21)

Distance Limitations for Interface Cables

When planning your installation, consider distance limitations and potential electromagnetic interference (EMI) as defined by the Electronic Industries Association (EIA). Distance limitation information is included for the following VG ports:

- [Gigabit Ethernet Maximum Distance, page 3-4](#)
- [FXS Analog Voice Port Maximum Distance, page 3-4](#)
- [FXS-E \(Extended loop\) Analog Voice Port Maximum Distance, page 3-4](#)

Gigabit Ethernet Maximum Distance

The maximum segment distance for Gigabit Ethernet is 330 feet (100 meters) (specified in IEEE 802.3).

FXS Analog Voice Port Maximum Distance

The maximum distance is established by a total allowable loop resistance, including the phone or terminal equipment, of 600 ohms.

FXS-E (Extended loop) Analog Voice Port Maximum Distance

The maximum distance is established by a total allowable loop resistance, including the phone or terminal equipment, of 1400 ohms.

**Note**

Typically, a 26 AWG wire is equal to 81.6 ohm/Kft and 24 AWG wire is equal to 51.3 ohm/Kft.

Interference Considerations

When you run cables for any significant distance in an electromagnetic field, interference can occur between the electromagnetic field and the signals on the cables. This has two implications for the installation of terminal plant cabling:

- Unshielded plant cabling can emit radio interference.
- Strong electromagnetic interference (EMI), especially as caused by lightning or radio transmitters, can destroy the EIA/TIA-232 drivers and receivers in the Cisco VG350 Voice Gateway.

If you use twisted-pair cables with a good distribution of grounding conductors in your plant cabling, emitted radio interference is unlikely.

If you have cables exceeding recommended distances, or if you have cables that pass between buildings, give special consideration to the effect of lightning strikes or ground loops. If your site has these characteristics, consult experts in lightning suppression and shielding. The electromagnetic pulse caused by lightning or other high-energy phenomena can easily couple enough energy into unshielded conductors to destroy electronic devices.

Most data centers cannot resolve the infrequent, but potentially catastrophic problems just described without pulse meters and other special equipment. Take precautions to avoid these problems by providing a properly grounded and shielded environment and by installing electrical surge suppression.

If you remove any module, you must either install a module in its place or install a cover plate over the opening. All module openings must be either occupied or covered to prevent electromagnetic interference.

For advice on the prevention of electromagnetic interference, consult experts in radio-frequency interference (RFI).



CHAPTER 4

Installing the Cisco VG350 Voice Gateway

This chapter contains the procedures for installing your Cisco VG350 Voice Gateway and consists of the following sections:

- [Safety Recommendations, page 4-2](#)
- [Site Log, page 4-5](#)
- [Keeping Track–Checklist, page 4-6](#)
- [Mounting Tools and Equipment, page 4-7](#)
- [Unpacking and Inspection, page 4-7](#)



Tip

While you do this installation, record your progress and site information. See the suggested format in the [“Keeping Track–Checklist”](#) section on page 4-6.



Warning

Only trained and qualified personnel should be allowed to install, replace, or service this equipment. Statement 1030



Warning

Read the installation instructions before connecting the system to the power source. Statement 1004

Safety Recommendations

The following information is included to alert you to safety recommendations and best practices when working with this equipment.

Maintaining Safety with Electricity

Follow these guidelines when working on equipment powered by electricity.



Warning

High leakage current—earth connection essential before connecting to system power supply.

Statement 342



Warning

When installing the product, please use the provided or designated connection cables/power cables/AC adaptors/batteries. Using any other cables/adaptors could cause a malfunction or a fire. Electrical Appliance and Material Safety Law prohibits the use of UL-certified cables (that have the "UL" or "CSA" shown on the cord), not regulated with the subject law by showing "PSE" on the cord, for any other electrical devices than products designated by CISCO. Statement 371



Warning

This product relies on the building's installation for short-circuit (overcurrent) protection. Ensure that the protective device is rated not greater than 15A minimum, 60VDC, 35A minimum, 60VDC, 45A minimum, 60VDC, or 50A minimum, 60VDC for the Circuit Breaker. Statement 1005



Warning

This equipment has been designed for connection to TN and IT power systems. Statement 1007



Warning

Class 1 laser product. Statement 1008



Warning

There is the danger of explosion if the battery is replaced incorrectly. Replace the battery only with the same or equivalent type recommended by the manufacturer. Dispose of used batteries according to the manufacturer's instructions. Statement 1015



Warning





Do not work on the system or connect or disconnect cables during periods of lightning activity.

Statement 1001



Warning

To avoid electric shock, do not connect safety extra-low voltage (SELV) circuits to telephone-network voltage (TNV) circuits. LAN ports contain SELV circuits, and WAN ports contain TNV circuits. Some LAN and WAN ports both use RJ-45 connectors. Use caution when connecting cables. Statement 1021

-  **Warning** This equipment must be grounded. Never defeat the ground conductor or operate the equipment in the absence of a suitably installed ground conductor. Contact the appropriate electrical inspection authority or an electrician if you are uncertain that suitable grounding is available. Statement 1024
-  **Warning** This unit might have more than one power supply connection. All connections must be removed to de-energize the unit. Statement 1028
-  **Warning** Blank faceplates and cover panels serve three important functions: they prevent exposure to hazardous voltages and currents inside the chassis; they contain electromagnetic interference (EMI) that might disrupt other equipment; and they direct the flow of cooling air through the chassis. Do not operate the system unless all cards, faceplates, front covers, and rear covers are in place. Statement 1029
-  **Warning** To prevent personal injury or damage to the chassis, never attempt to lift or tilt the chassis using the handles on modules (such as power supplies, fans, or cards); these types of handles are not designed to support the weight of the unit. Statement 1032
-  **Warning** Do not use this product near water; for example, near a bathtub, wash bowl, kitchen sink or laundry tub, in a wet basement, or near a swimming pool. Statement 1035
-  **Warning** Never install telephone jacks in wet locations unless the jack is specifically designed for wet locations. Statement 1036
-  **Warning** Never touch uninsulated telephone wires or terminals unless the telephone line has been disconnected at the network interface. Statement 1037
-  **Warning** Avoid using a telephone (other than a cordless type) during an electrical storm. There may be a remote risk of electric shock from lightning. Statement 1038
-  **Warning** To report a gas leak, do not use a telephone in the vicinity of the leak. Statement 1039
-  **Warning** Before opening the unit, disconnect the telephone-network cables to avoid contact with telephone-network voltages. Statement 1041

**Warning**

This equipment contains a ring signal generator (ringer), which is a source of hazardous voltage. Do not touch the RJ-11 (phone) port wires (conductors), the conductors of a cable connected to the RJ-11 port, or the associated circuit-board when the ringer is active. The ringer is activated by an incoming call. Statement 1042

**Warning**

For diverging beams, viewing the laser output with certain optical instruments within a distance of 100 mm may harm your eyes. For collimated beams, viewing the laser output with certain optical instruments designed for use at a distance may harm your eyes. Statement 1054

**Warning**

Installation of the equipment must comply with local and national electrical codes. Statement 1074

General Safety Practices

Follow these guidelines to ensure personal safety and to protect the equipment:

- Keep the chassis area clear and dust-free during and after installation.
- Put the removed chassis cover in a safe place.
- Keep tools away from walk areas where you and others could fall over them.
- Do not wear loose clothing that could get caught in the chassis.
- Wear safety glasses if you are working under any conditions that might be hazardous to your eyes.

**Warning**

This equipment must be installed and maintained by service personnel as defined by AS/NZS 3260. Incorrectly connecting this equipment to a general-purpose outlet could be hazardous. The telecommunications lines must be disconnected 1) before unplugging the main power connector or 2) while the housing is open, or both. Statement 1043

Safety Tips

Use these tips as safety guidelines when installing or working around this equipment:

- Locate the emergency Power-off switch for the room in which you are working. Then, if an electrical accident occurs, you can act quickly to turn off the power.
- Disconnect all power before installing or removing a chassis.
- Do not work alone if potentially hazardous conditions exist.
- Never assume that power is disconnected from a circuit. Always check.
- Look carefully for possible hazards in your work area, such as moist floors, ungrounded power extension cables, and missing safety grounds.
- If an electrical accident occurs, proceed as follows:
 - Use caution; do not become a victim yourself.
 - Turn off power to the system.

- If possible, send another person to get medical aid. Otherwise, assess the condition of the victim and then call for help.
- Determine if the person needs rescue breathing or external cardiac compressions; then take appropriate action.

Preventing Electrostatic Discharge Damage

Electrostatic discharge (ESD) can damage equipment and impair electrical circuitry. ESD occurs when electronic components are improperly handled; it can result in complete or intermittent failures.

Always follow ESD-prevention procedures when removing and replacing components.

- Ensure that the chassis is electrically connected to earth ground.
- Wear an ESD-preventive wrist strap, ensuring that it makes good skin contact.
- Connect the clip to the ESD-strap connection jack (to the left of the power switch on the rear of the chassis) or to an unpainted chassis frame surface.



Caution

For safety, periodically check the resistance value of the antistatic strap, which should be between 1 and 10 megohm (Mohm).

Site Log

We recommend that you maintain a Site Log to record all actions relevant to the system. Site Log entries might include the following:

- Installation—Print a copy of the Installation Checklist and insert it into the Site Log.
- Upgrades and maintenance—Use the Site Log to record ongoing maintenance and expansion history. Update the Site Log to reflect the following:
 - Configuration changes
 - Maintenance schedules, requirements, and procedures performed
 - Comments, notes, and problems
 - Changes and updates to Cisco IOS software

Keeping Track–Checklist

We recommend that you use an installation checklist and maintain a Site Log.

Installation Checklist

The Installation Checklist (see [Figure 4-1](#)) lists the tasks for installing a Cisco VG350 Voice Gateway. Print a copy of this checklist and mark the entries as you complete each task. For each Cisco VG350 Voice Gateway, include a copy of the checklist in your Site Log.

Figure 4-1 **Installation Checklist**

Installation Checklist for site _____

Cisco VG name/serial number _____

| Task | Verified by | Date |
|--|-------------|------|
| Background information placed in Site Log | | |
| Environmental specifications verified | | |
| Site power voltages verified | | |
| Installation site prepower check completed | | |
| Required tools available | | |
| Additional equipment available | | |
| Cisco VG received | | |
| Quick start guide received | | |
| Regulatory compliance and safety information received | | |
| Information packet, warranty card, and Cisco.com card received | | |
| Software version verified | | |
| Rack, desktop, or wall-mounting of chassis completed | | |
| Initial electrical connections established | | |
| ASCII terminal attached to console port | | |
| Modem attached to console port (for remote configuration) | | |
| Signal distance limits verified | | |
| Startup sequence steps completed | | |
| Initial operation verified | | |

Mounting Tools and Equipment

Obtain the following tools and parts to install a Cisco VG350 Voice Gateway:

- Standard flat-blade screwdriver as required for attaching brackets to rack or wall
- Phillips screwdriver for attaching brackets to a Cisco VG350 Voice Gateway
- Mounting brackets and screws for 24-inch rack, if required:
 - Four telco machine screws, for installing the chassis in a rack (use the screw size required by the rack)
- Screws and anchors for wall-mounting, if required
 - Eight wood screws or other fasteners, for installing the chassis on a wall. An additional starter screw can be used to facilitate wall-mounting.
- ESD-preventive wrist strap

In addition, you might need the following external equipment:

- Console terminal or PC with terminal emulation software
- PC running terminal emulation software for administrative access
- Modem for remote access
- Analog voice RJ-21 cable
- Ethernet switch
- Modem for remote configuration

Unpacking and Inspection

Do not unpack the Cisco VG350 until you are ready to install it. If the installation site is not ready, keep the chassis in its shipping container to prevent accidental damage.

The Cisco VG350, cables, printed publications, and any optional equipment you ordered might be shipped in more than one container. When you unpack each shipping container, check the packing list to ensure that you received all the following items:

- Cisco VG350 Voice Gateway
- Power cord, 6-foot (1.8-meter)
- RJ-45-to-DB-25 adapter cable (labeled *Console*)
- RJ-45-to-DB-9 adapter cable (labeled *Auxiliary*)
- Rack-mounting brackets for 19-inch rack (one pair) with screws for attaching to chassis
- Chassis guard for wall-mounting applications
- Grounding lug and fasteners
- *Read Me First* for Cisco VG350 Voice Gateway

Inspect all items for shipping damage. If anything appears damaged, or if you encounter problems when installing or configuring your system, contact a customer service representative. (See the [“Obtaining Documentation”](#) section on page -xv.)



CHAPTER 5

Powering On the Cisco VG350 Voice Gateway

To power on your Cisco VG350 Voice Gateway, perform the following tasks in the order listed, as required:

- [Checklist for Power-On, page 5-1](#)
- [Power-On Procedure, page 5-1](#)
- [Troubleshooting, page 5-3](#)

Checklist for Power-On

You can power on a Cisco VG350 Voice Gateway if it meets the requirements described in [Chapter 4, “Installing the Cisco VG350 Voice Gateway”](#):

- The chassis is securely mounted.
- Power cable is connected.
- Interface cables are connected.

Power-On Procedure

Perform this procedure to power on your Cisco VG350 Voice Gateway, and verify that it goes through its initialization and self-test. When this is finished, the Cisco VG350 Voice Gateway is ready to configure.



Warning

This unit might have more than one power supply connection. All connections must be removed to de-energize the unit. Statement 1028



Warning

Installation of the equipment must comply with local and national electrical codes. Statement 1074

To power on the Cisco VG350 Voice Gateway, perform the following:

Step 1 Power on your terminal or PC, and configure it for 9600 bps, 8 data bits, 1 stop bit, and no parity.

Step 2 Move the Cisco VG350 Voice Gateway power switch to the ON position.

The green LED next to the auxiliary port should come on and the fan should operate. If this does not happen, see the [“Troubleshooting” section on page 5-3](#).

The following message is displayed at the end of the boot-up messages:

```
--- System Configuration Dialog ---
Would you like to enter the initial configuration dialog? [yes/no]:
```

Step 3 Enter **no** to proceed with manual configuration using the CLI:

```
Would you like to enter the initial configuration dialog? [yes/no]: no
Would you like to terminate autoinstall? [yes]
```

Step 4 Press **Return** to terminate autoinstall and continue with manual configuration.

Several messages are displayed, ending with a line similar to the following:

```
...
Copyright (c) 1986-2003 by cisco Systems, Inc.
Compiled <date> <time> by <person>
```

Step 5 Press **Return** to bring up the `Router>` prompt:

```
...
flashfs[4]: Initialization complete.
Router>
```

Step 6 Enter privileged EXEC mode:

```
Router> enable
Router#
```

Step 7 Continue with the [“Troubleshooting” section on page 5-3](#).



Note

If the `rommon 1>` prompt appears, your system has booted in ROM monitor mode. For information on the ROM monitor, refer to the router rebooting and ROM monitor information in the [Cisco IOS Configuration Fundamentals Configuration Guide](#) for your Cisco IOS software release.

Troubleshooting

This section describes possible mechanical problems and corrective actions.



Warning

Only trained and qualified personnel should be allowed to install, replace, or service this equipment.
Statement 1030



Warning

No user-serviceable parts inside. Do not open. Statement 1073

If there appears to be a malfunction, first check all cables and connections. If these are in order, see [Table 5-1](#) for specific troubles and solutions.

For problems with the configuration, refer to [Cisco VG350 Voice Gateway Software Configuration Guide](#).

Table 5-1 Troubleshooting the Cisco VG350 Voice Gateway

| Symptom | Possible Cause | Corrective Action |
|--|-------------------------------|--|
| Power LED and fan are off | Power source switched off | Switch power source on |
| | Faulty power cable | Check/replace power cable |
| | Faulty power source | Check/correct input power |
| | Faulty internal power supply | Contact Cisco ¹ or your Cisco reseller |
| Power LED on; fan off | Faulty Cisco VG350 | Contact Cisco ¹ Technical Service Center or your Cisco reseller |
| Power LED off; fan on | Faulty Cisco VG350 | Contact Cisco ¹ or your Cisco reseller |
| No initialization response from Cisco VG350 | Faulty modem console terminal | Check/replace modem/terminal |
| | Faulty cabling to terminal | Check/replace cable |
| | Faulty Cisco VG350 | Contact Cisco ¹ or your Cisco reseller |
| Unit shuts off after operating for some time | Overheating | Check ventilation |
| | Faulty Cisco VG350 | Contact Cisco ¹ or your Cisco reseller |
| Console screen display freezes | Console fault | Reset/replace console |
| | Software error | Repeat power-on procedure |
| | Faulty Cisco VG350 | Contact Cisco ¹ or your Cisco reseller |

1. See the “Obtaining Technical Assistance” section on page xvi.



APPENDIX **A**

Cable Specifications and Information

This appendix provides the connector and pinout information you need for making or purchasing cables used with Cisco VG350 Voice Gateway. To order cables from Cisco, see the “[Obtaining Technical Assistance](#)” section on page xvi. This appendix contains the following sections:

- [Console and Auxiliary Port Cables and Pinouts](#), page A-1
- [Gigabit Ethernet Port Pinouts \(RJ-45\)](#), page A-5
- [Analog Voice Multiport Pinouts \(RJ-21X/CA21A\)](#), page A-6

The following list shows you which table to see for pinout information:

| Cisco VG350 Voice Gateway Port and Connection Type | Pinout Information |
|---|---------------------------------------|
| Console Port to PC—Cable Pinouts (RJ-45 to DB-9) | Table A-1 on page A-2 |
| Console Port to ASCII Terminal—Cable Pinouts (RJ-45 to DB-25) | Table A-2 on page A-3 |
| Auxiliary Port to Modem—Cable Pinouts (RJ-45 to DB-25) | Table A-3 on page A-4 |
| Alternative Terminal and Modem Connections | Table A-4 on page A-4 |
| Gigabit Ethernet Port Pinouts (RJ-45) | Table A-5 on page A-5 |

Console and Auxiliary Port Cables and Pinouts

Your Cisco VG350 Voice Gateway comes with the cable and adapters you need to connect a PC, an ASCII terminal, or a modem to your Cisco VG350 Voice Gateway. The cable kit includes:

- RJ-45-to-RJ-45 rollover cable
- RJ-45-to-DB-9 adapter cable for console connection
- RJ-45-to-DB-25 adapter cable for modem connection

The following illustrations and tables provide cable pinout information:

- Console port to a PC—See [Table A-1](#) and [Table A-4](#)
- Console port to an ASCII terminal—See [Table A-2](#) and [Table A-4](#)
- Auxiliary port to a modem—See [Table A-3](#) and [Table A-4](#)

The console port is configured as data communications equipment (DCE); the auxiliary port is configured as data terminal equipment (DTE). Both are asynchronous serial ports and use RJ-45 connectors.

Console Port to PC

Figure A-1 shows the RJ-45-to-RJ-45 rollover cable assembly and the RJ-45-to-DB-9 female DTE adapter (labeled TERMINAL); Table A-1 lists the pinouts.

Figure A-1 Console Port to PC—Cable and Adapter

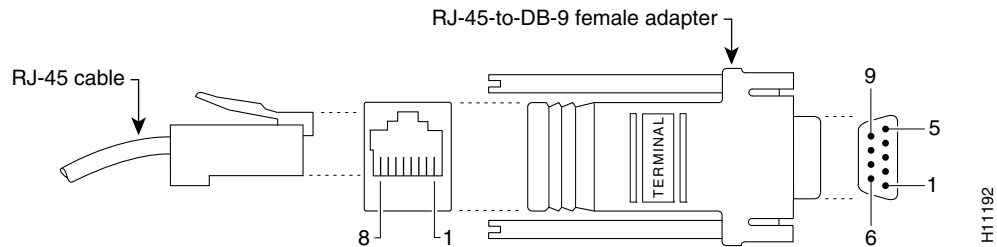

Table A-1 Console Port to PC—Cable Pinouts (RJ-45 to DB-9)

| Console Port (DCE, RJ-45) | RJ-45-to-RJ-45 Rollover Cable | | RJ-45-to-DB-9 Adapter "TERMINAL" | | PC Port (DTE, DB-9) |
|------------------------------|----------------------------------|-----------|-------------------------------------|----------|------------------------|
| | RJ-45 Pin | RJ-45 Pin | RJ-45 Pin | DB-9 Pin | |
| RTS | 1 ¹ | 8 | 8 | 8 | CTS |
| DTR | 2 | 7 | 7 | 6 | DSR |
| TxD | 3 | 6 | 6 | 2 | RxD |
| GND | 4 | 5 | 5 | 5 | GND |
| GND | 5 | 4 | 4 | 5 | GND |
| RxD | 6 | 3 | 3 | 3 | TxD |
| DSR | 7 | 2 | 2 | 4 | DTR |
| CTS | 8 ¹ | 1 | 1 | 7 | RTS |

1. Pin 1 is connected to pin 8 inside the Cisco VG350 Voice Gateway.

H11192

Console Port to ASCII Terminal

Figure A-2 shows the RJ-45-to-RJ-45 rollover cable assembly and the RJ-45-to-DB-25 female DTE adapter (labeled TERMINAL); Table A-2 lists the pinouts.

Figure A-2 Console Port to ASCII Terminal—Cable and Adapter

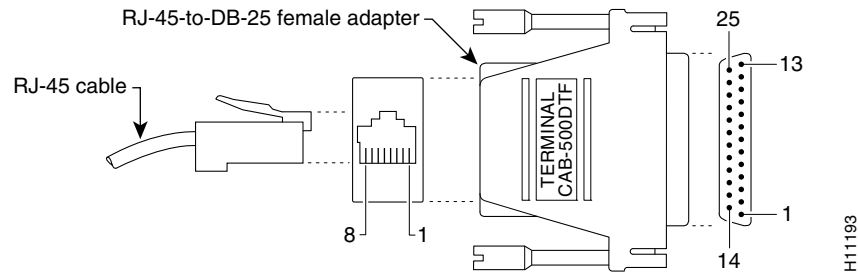

Table A-2 Console Port to ASCII Terminal—Cable Pinouts (RJ-45 to DB-25)

| Console Port (DCE, RJ-45) | RJ-45-to-RJ-45 Rollover Cable | | RJ-45-to-DB-25 Adapter "TERMINAL" | | Terminal Port (DTE, DB-25) |
|------------------------------|----------------------------------|-----------|--------------------------------------|-----------|-------------------------------|
| | RJ-45 Pin | RJ-45 Pin | RJ-45 Pin | DB-25 Pin | |
| RTS | 1 ¹ | 8 | 8 | 5 | CTS |
| DTR | 2 | 7 | 7 | 6 | DSR |
| TxD | 3 | 6 | 6 | 3 | RxD |
| GND | 4 | 5 | 5 | 7 | GND |
| GND | 5 | 4 | 4 | 7 | GND |
| RxD | 6 | 3 | 3 | 2 | TxD |
| DSR | 7 | 2 | 2 | 20 | DTR |
| CTS | 8 ¹ | 1 | 1 | 4 | RTS |

1. Pin 1 is connected to pin 8 inside the Cisco VG350 Voice Gateway.

Auxiliary Port to Modem

Figure A-3 shows the RJ-45-to-RJ-45 rollover cable assembly and the RJ-45-to-DB-25 male DCE adapter (labeled MODEM); Table A-3 lists the pinouts.

Figure A-3 Auxiliary Port to Modem—Cable and Adapter

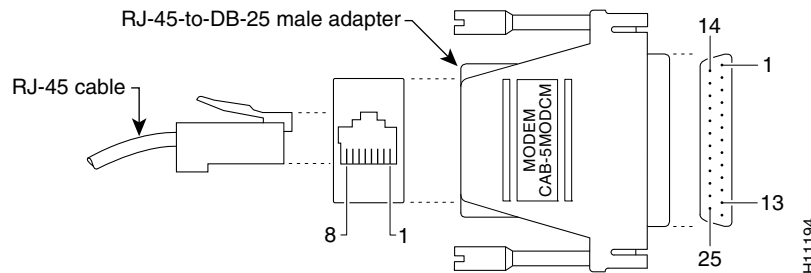

Table A-3 Auxiliary Port to Modem—Cable Pinouts (RJ-45 to DB-25)

| Auxiliary Port (DTE, RJ-45) | RJ-45-to-RJ-45 Rollover Cable | | RJ-45-to-DB-25 Adapter "MODEM" | | Modem Port (DCE, DB-25) |
|--------------------------------|----------------------------------|-----------|-----------------------------------|-----------|----------------------------|
| | RJ-45 Pin | RJ-45 Pin | RJ-45 Pin | DB-25 Pin | |
| RTS | 1 | 8 | 8 | 4 | RTS |
| DTR | 2 | 7 | 7 | 20 | DTR |
| TxD | 3 | 6 | 6 | 2 | TxD |
| GND | 4 | 5 | 5 | 7 | GND |
| GND | 5 | 4 | 4 | 7 | GND |
| RxD | 6 | 3 | 3 | 3 | RxD |
| DSR | 7 | 2 | 2 | 8 | DCD |
| CTS | 8 | 1 | 1 | 5 | CTS |

Alternative Connections to Terminal and Modem

Your Cisco VG350 Voice Gateway ships with an RJ-45-to-RJ-45 rollover cable and two adapters for connection to a PC, a terminal, or a modem. If you want to use an RJ-45 straight-through cable or other adapters, see Table A-4 for usable cable and adapter combinations.

Table A-4 Alternative Terminal and Modem Connections

| Cisco VG350 Port Connection | RJ-45 Cable Type | Adapter |
|--------------------------------|-----------------------|--------------------------------|
| Console port to PC | Straight-through | DCE, DB-9 female |
| Auxiliary port to modem | Rollover ¹ | DCE ² , DB-25, male |
| | Straight-through | DTE ² , DB-25, male |

1. An octal cable or RJ-45 breakout cable is equivalent to a rollover cable.
2. Modify the DB-25 adapter by removing the wire in pin 6 and placing it in the pin 8 position.

Gigabit Ethernet Port Pinouts (RJ-45)

Figure A-4 shows the RJ-45 connector wiring for the Gigabit Ethernet cable; Figure A-4 lists the pinouts.

Note

Pinout shown is for category 3, 4, or 5 10/100BASE-T connection to an Gigabit Ethernet switch.

Figure A-4 RJ-45 Connector Wiring

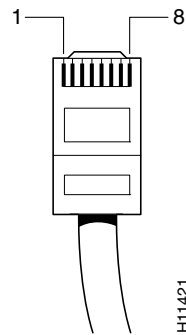

Table A-5 Gigabit Ethernet Port Pinouts (RJ-45)

| Pin ¹ | Signal |
|------------------|--------|
| 1 | TX+ |
| 2 | TX- |
| 3 | RX+ |
| 4 | - |
| 5 | - |
| 6 | RX- |
| 7 | - |
| 8 | - |

1. Any pin not referenced is not connected.

Analog Voice Multiport Pinouts (RJ-21X/CA21A)

Figure A-5 shows the RJ-21 connector wiring for the cable used for the multiport analog voice interface.

Figure A-5 RJ-21 Connector Wiring

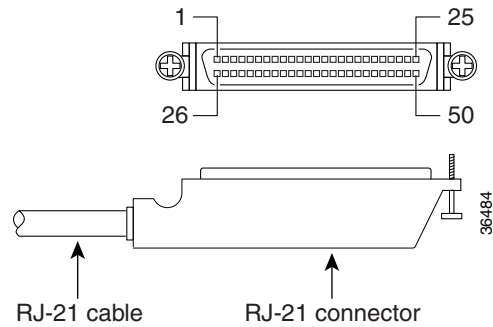

Table A-6 lists the pinouts for the RJ-21 connector.

Table A-6 RJ-21 Connector Pinouts

| Port Number | Connector Pin Number | Signal | Port Number | Connector Pin Number | Signal |
|-------------|----------------------|-------------|-------------|----------------------|-------------|
| 1 | 1 26 | Ring Tip | 13 | 13 38 | Ring Tip |
| 2 | 2 27 | Ring Tip | 14 | 14 39 | Ring Tip |
| 3 | 3 28 | Ring Tip | 15 | 15 40 | Ring Tip |
| 4 | 4 29 | Ring Tip | 16 | 16 41 | Ring Tip |
| 5 | 5 30 | Ring Tip | 17 | 17 42 | Ring Tip |
| 6 | 6 31 | Ring Tip | 18 | 18 43 | Ring Tip |
| 7 | 7 32 | Ring Tip | 19 | 19 44 | Ring Tip |
| 8 | 8 33 | Ring Tip | 20 | 20 45 | Ring Tip |
| 9 | 9 34 | Ring Tip | 21 | 21 46 | Ring Tip |
| 10 | 10 35 | Ring Tip | 22 | 22 47 | Ring Tip |
| 11 | 11 36 | Ring Tip | 23 | 23 48 | Ring Tip |

Table A-6 *RJ-21 Connector Pinouts (continued)*

| Port Number | Connector Pin Number | Signal | Port Number | Connector Pin Number | Signal |
|--------------------|-----------------------------|---------------|--------------------|-----------------------------|---------------|
| 12 | 12 37 | Ring Tip | 24 | 24 49 | Ring Tip |
| — | — | — | — | 25, 50, 51, 52 | GND |